



Product Catalog

Pub. C10001-V45 and copyright 2024



On behalf of our organization, thank you for considering SunModo for your racking needs.

At SunModo, we are dedicated to supporting professional installers with robust and worry-free products, great technical support, and a complete line of innovative racking and mounting solutions.

We look forward to working with you!

-The SunModo Team

SMR PITCHED ROOF SYSTEM

- Overview.....3
- SMR100.....4
- Clamps.....5
- Rail Splice.....5
- Components.....6

NanoRack

NEW

- Overview.....7
- Components.....8

Roof Attachments

Composite Shingle Roof

- Nano Family.....11
- SoloFlash.....12

Metal Roof

- MRB.....13
- NanoBit.....14
- Standing Seam Clamp **COMING SOON**.....15

Tile Roof

- TopTile Mount.....16

Contact Information

Phone:	1-360-844-0048
Fax:	1-503-863-3878
General:	info@sunmodo.com
Sales:	sales@sunmodo.com
Website:	www.sunmodo.com

Disclaimer

Due to continuous product optimization, we reserve the right to change our product information and this product catalog at any time. All previous product catalog information becomes invalid upon the release of later publications.

Roof Attachments

- L-Foot.....17
- Conduit Clip.....17

SMR Tilt-Up System

- Overview.....18
- Components.....19

SunTurf Ground Mount System

- Overview.....20
- SMR300.....21
- Components.....22



SMR Pitched Roof System

SunModo introduces the SMR System, the best value-pitched roof mounting system on the market. The SMR System represents a huge leap in racking technology. The optimized design makes the SMR Rails not only the lightest but also the strongest rails on the market. With fast and easy Pop-On Clamps and L-Foot Adaptors, professional installers can mount, adjust, and secure PV panels with a single tool. Save money on materials and installation time.

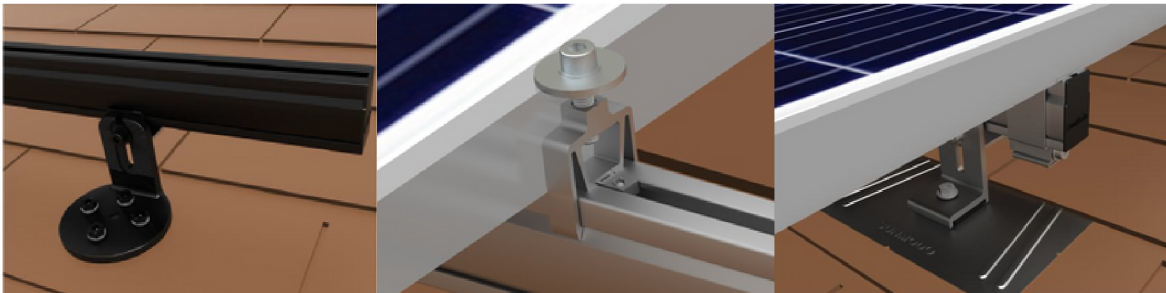

A full range of mounts available (NanoMount shown) to best fit your system needs and requirements.

The Bonding Pop-On Universal Mid Clamps accommodate PV module frame heights ranging from 30mm to 48mm.

Pop-On End Clamps are adjustable for different module frame heights and provide fast and secure attachment of modules.

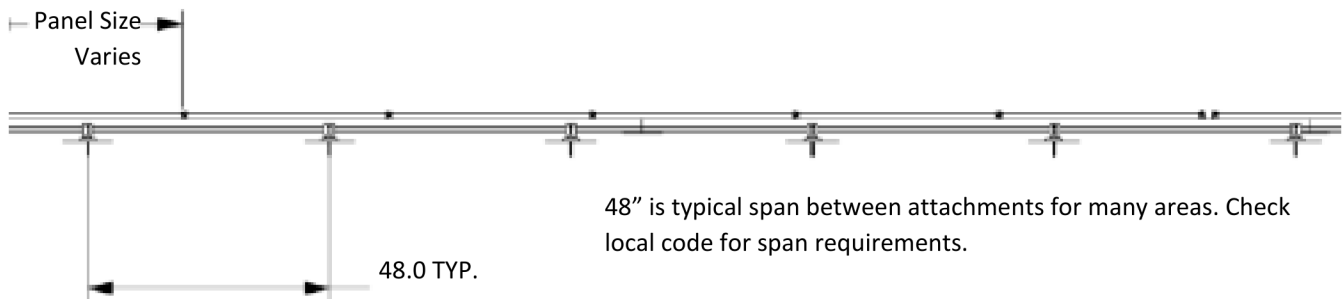

SMR100

The SMR System represents a huge leap in racking technology. The optimized design makes the SMR Rails not only the lightest but also the strongest rails on the market.

SMR100 Rail achieves a 4' span or more up to 90 psf snow load or 190 mph winds.

Manufactured in 168" stock size in both Mill Finish and Black. SMR100 is extruded 6005-T5 aluminum.

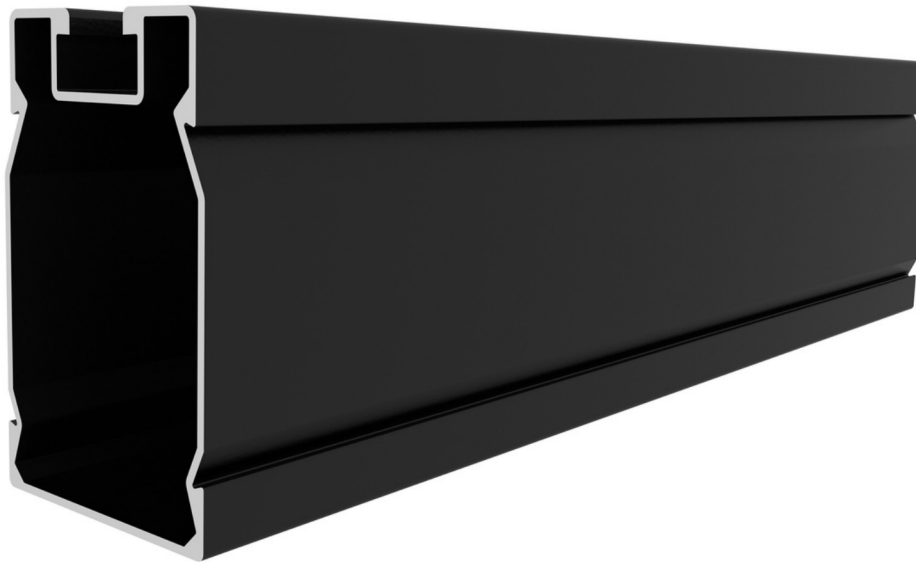

Part Number	Description
A20422-168-ML	SMR100 Rail, 168", Mill Finish
A20422-168-BK	SMR100 Rail, 168", Black Anodized
CAP-SMR100-B	Rail End Cap, SMR100, Black
CAP-SMR100-G	Rail End Cap, SMR100, Gray



SMR Pop-On Mid Clamp

The Bonding Pop-On Universal Mid Clamps accommodate PV module frame heights ranging from 30mm to 48mm. The fastest installing Mid Clamps on the market.



Part Number	Description
K10417-004	Mid Clamp, SMR Pop-On, Silver
K10417-BK4	Mid Clamp, SMR Pop-On, Black

SMR Pop-On End Clamp

End Clamps are adjustable for different module frame heights and provide fast and secure attachment of modules.



Part Number	Description
K10418-004	End Clamp, SMR Pop-On, Silver
K10418-BK4	End Clamp, SMR Pop-On, Black

Bottom End Clamp

The SMR100 Bottom Clamp secures the PV panel frame flange to the Rail, which allows the Rail to be cut flush with the module frame.



Part Number	Description
K10505-001	Bottom End Clamp, SMR100, Silver
K10505-BK1	Bottom End Clamp, SMR100, Black

SMR Structural Splice

Structural splice with fast and easy single bolt installation.



Part Number	Description
K10421-004	Rail Splice, SMR100
K10485-002	Rail Splice, SMR300



SMR L- Foot Adaptor

Fast and easy Pop-On L-Foot Adaptor speeds installation and eliminates old-fashioned T-Bolts. Install fast with full confidence in every attachment.



Part Number	Description
K10433-BK2	L Foot Adaptor, SMR100, Black
K10434-BK2	L Foot Adaptor, SMR300, Black

Grounding Lug

The Grounding Lug provides proper grounding of the PV System per UL 2703 and NEC 690.47

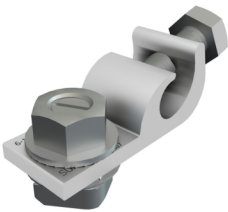

Part Number	Description
K10469-001	Grounding Lug, SMR

Wire Management Clip

The clip attaches to the channel on the SMR rail to provide a fast and secure solution for wire management.



Part Number	Description
C10055-BK1	Wire Management Clip, SMR100

Microinverter Mount

The Microinverter Mount bonds to compatible microinverters and power optimizers.



Part Number	Description
K50052-003	MLPE Mount, SMR



NanoRack™ 3 Hour Install - Start to Finish

SunModo proudly introduces NanoRack™. There isn't any rail, but it's unlike any other rail-free system on the market. NanoRack™ solves the rail-free headaches of precise measuring and complex wire management. Assemble it on the ground, and it aligns itself on the roof. Save money & time on every job with NanoRack™.



On the ground, NanoRack components and MLPE are attached directly to the modules.

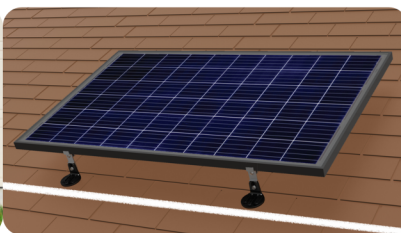

Identify location of the first row of modules and snap a line. No other measuring required.

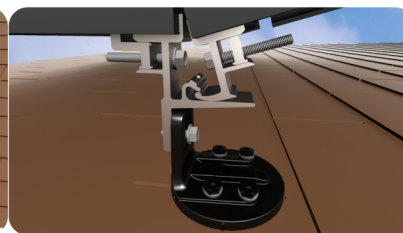

Modules are automatically aligned with adjacent modules with the patent-pending hook and loop feature. No adjustment needed.



The skirt gives the NanoRack System a clean look, either on just the front edge or around the entire perimeter of the array if desired.



Universal Bracket

Module attachment bracket for middle or edge of array.

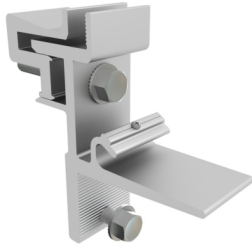

Part Number	Description
NANORACK-UNI	NanoRack Universal Bracket

Module Hook

Module attachment hook assembly.

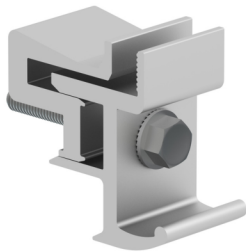

Part Number	Description
NANORACK-HOOK	NanoRack Module Hook

End Bracket

Module attachment bracket for leading or trailing edge of array.



Part Number	Description
NANORACK-END	NanoRack End Bracket

NanoPlus/Deck Screw

The NanoPlus offers deck mounting on any composite shingle roof. This roof attachment offers 1" of vertical height adjustment.



Part Number	Description
NANOPLUS-B	NanoPlus
SCREW-B	Deck Screw



MLPE Mount, Module

Attach the Module Level Power Equipment (MLPE) to the module frame using the MLPE Mount.

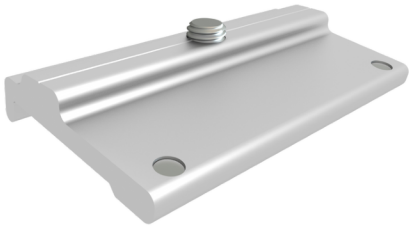

Part Number	Description
MLPE-MODULE	MLPE Mount, Module

Skirt

The Skirt has been designed to provide 360-degree skirting of the entire array if desired.

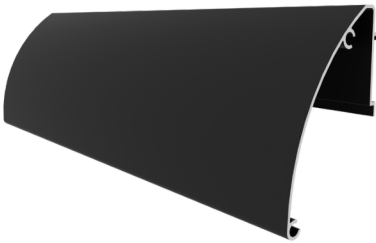

Part Number	Description
SKIRT-84-B	Skirt, 84", Black

Skirt Clamp

Attach the Skirt to the module frame using the Skirt Clamp.

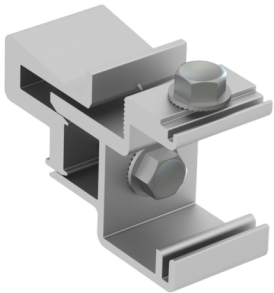

Part Number	Description
SKIRT-CLAMP	Skirt Clamp

Skirt Splice Clamp

Skirt Splice Clamps are used where the ends of two Skirt pieces meet along the module edge.

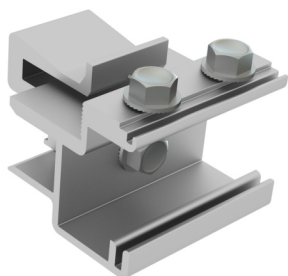

Part Number	Description
SKIRT-SPLICE	Skirt Splice Clamp



Skirt End Cap

End Caps cover the ends of the Skirt giving the solar array a clean and professional finished look.



Part Number	Description
SKIRT-CAP-B	Skirt End Cap, Pair, Black

Skirt Inside Corner

The Inner Corners provide the flexibility to attach the Skirt to the full perimeter of any shaped solar array.



Part Number	Description
SKIRT-INNER-B	Skirt, Inside Corner, Black

Skirt Outside Corner

The Outside Corners provide the flexibility to attach the Skirt to the full perimeter of any shaped solar array.

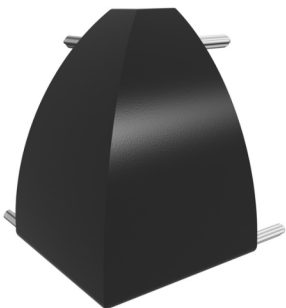

Part Number	Description
SKIRT-OUTER-B	Skirt Outside Corner, Black



Nano Family

Damaging roof shingles used to be one of solar installers' worst challenges.

Now, the easy, affordable solution is Nano Family, SunModo's patented solar mounting innovations. NanoMount® and NanoBit™ eliminate the need for lifting the shingle and dramatically cuts down the installation time.

The patented mounts are High-Velocity Hurricane Zone Approved – Passed TAS 100 (a) Wind-Driven Rain Test. The Ultra Soft Weather Resistant gaskets are integrated with the mounts.

All materials are compatible with residential roof coverings as well as commercial single-ply roof membranes.



Part Number	Description
K50058-BK1	NanoMount, Black
K50049-BK1	Lag Bolt, Black
K50055-BK2	Deck Screw, Black
K50065-BK1	NanoBit, with Lag Bolt, Black



SoloFlash™

SunModo is proud to introduce SoloFlash™, the most economical flashing on the market.

The cone-shaped flashing design diverts water from the roof penetration, while the stamped emboss features stiffen the flashing to minimize bending. The L-foot has a serrated surface on both sides for rail mounting. The Ultra Soft Weather Resistant gasket is integrated with the L-Foot for maximum water protection.

The mount is High-Velocity Hurricane Zone Approved – Passed TAS 100 (a) Wind-Driven Rain Test.

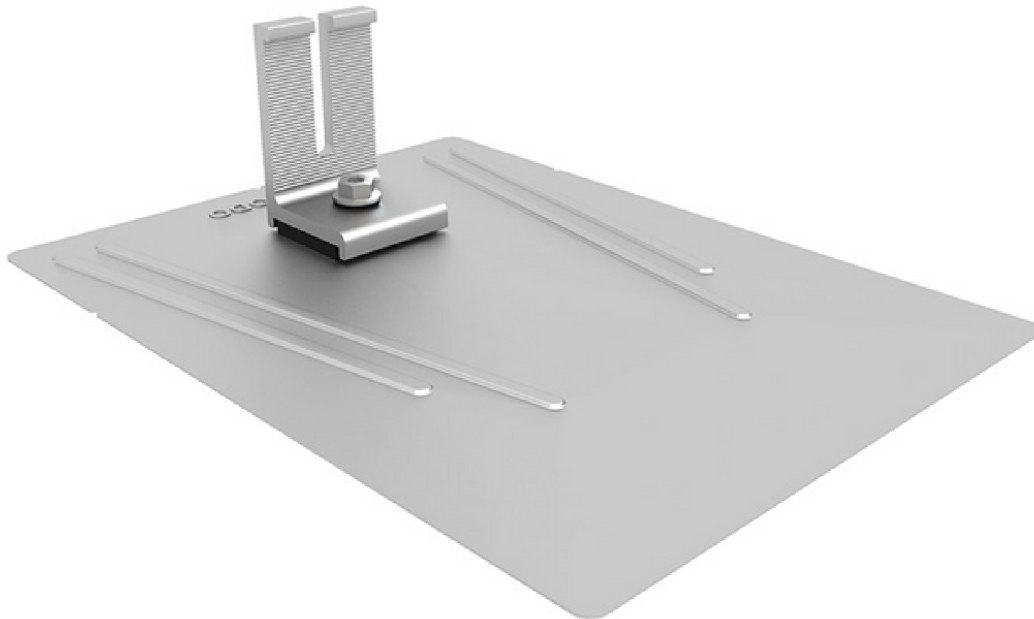

Part Number	Description
K50538-003	SoloFlash, Silver
K50538-BK3	SoloFlash, Black



MRB™

SunModo is proud to introduce MRB™, the most versatile metal roof attachment on the market.

Specially designed to work for metal roof profiles, MRB™ makes easy work of any metal roof installation. Pair it with our SMR pitched roof system, and you'll be on and off the roof in record time.

The mount is High-Velocity Hurricane Zone Approved and Passed TAS 100 (a) Wind-Driven Rain Test.

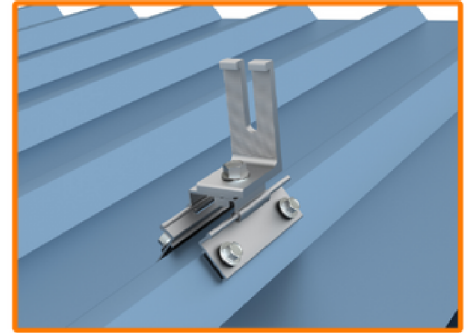
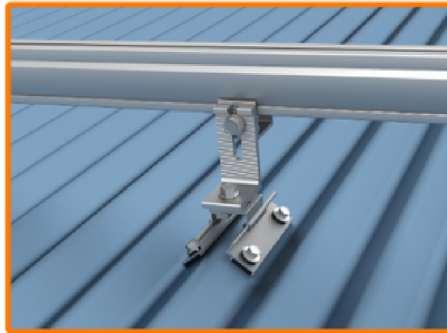
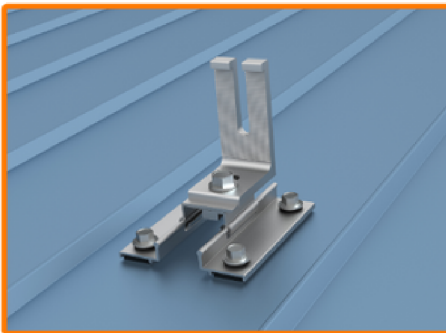
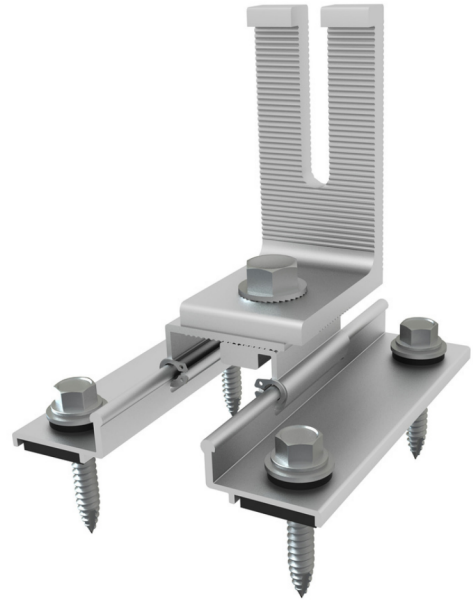

Part Number	Description
K50563-002	MRB Mount, Silver



NanoBit™

SunModo is proud to introduce our latest innovation NanoBit™, Solar's Fastest Attachment for Metal Roof.

Specially engineered for easy installation, NanoBit™ is the fastest installing metal roof mount in the industry. Pair it with our SMR pitched roof system, and you'll be on and off the roof in record time.

The mount is High-Velocity Hurricane Zone Approved and Passed TAS 100 (a) Wind-Driven Rain Test.



Part Number	Description
K50065-BK1	NanoBit, with Lag Bolt, Black



Standing Seam Clamp

Solar PV installations on standing seam roofs just got easier with SunModo's Standing Seam Clamp.

No rail needed! SMR Mid and End Clamps attach directly to the Standing Seam Clamp. Save the cost and time of using rail.

Simply attach an L-Foot and the same Standing Seam Clamp can be used with a rail-based system.

**COMING
SOON**

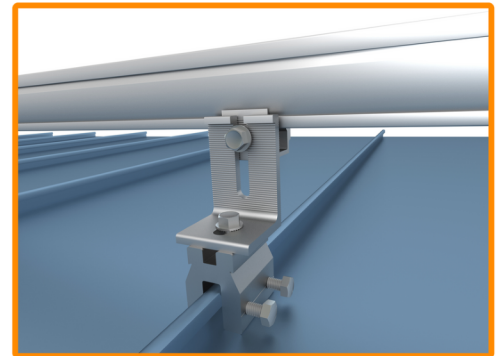
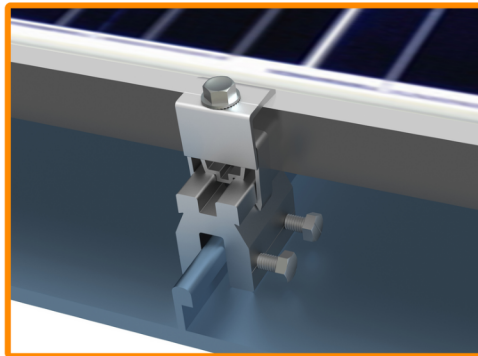
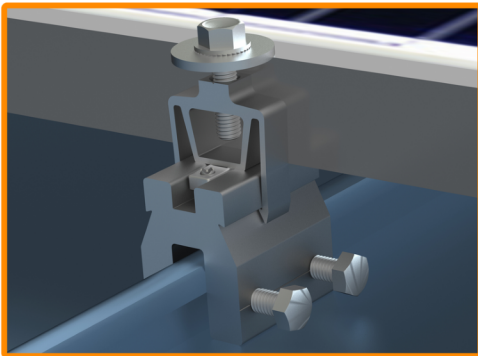
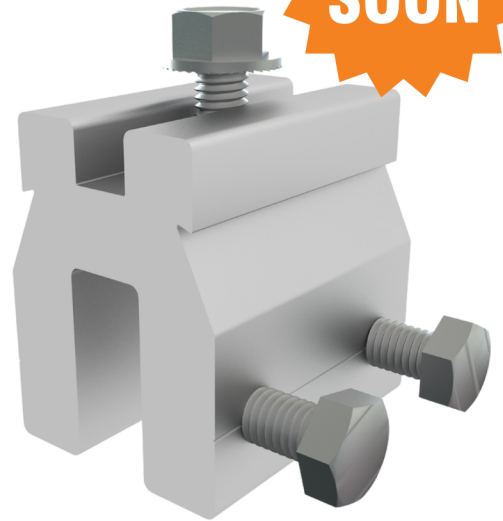

Part Number

Description

SS-13-S

Standing Seam Clamp, 13mm, Rail-less or
Rail compatible, Silver



TopTile Mount®

TopTile® is the world's first PV mounting system that is mounted entirely above the tiles. The mounting system spares an installer the need to deconstruct the tile roof.

The patented mount eliminates the need to deconstruct the tile roof and significantly reduces time, and minimizes tile breakage during installation. The system also allows installation on the ridges of curved tiles for superior water leak protection.

The mount is High-Velocity Hurricane Zone Approved – Passed TAS 100 (a) Wind-Driven Rain Test.



Part Number	Description
TOPTILE 5-B	TopTile, 5", Black
TOPTILE 7-B	TopTile, 7", Black
A20452-001	TopTile Spacer, 1", Silver



L-Foot Kits

SunModo L-Foot Kits are heavy-duty and can be used in a variety of ways for mounting. One long vertical slot for adjustment of rail when facing uneven roofing. Serrated on both sides for secure mounting on the rail. We also offer a Tall L-Foot version that gives you more flexibility on vertical adjustments.



Part Number	Description
A50223-002	Open L-Foot, 3", Silver
A50223-BK2	Open L-Foot, 3", Black
A20458-001	Open L-Foot, 4", Silver
A20458-BK1	Open L-Foot, 4", Black

Conduit Clip

The Conduit Clip provides a quick and easy way to manage 3/4" and 1" diameter conduit to any rooftop solar installation.



Part Number	Description
K10429-002	Conduit Clamp, 1", Silver
K10430-002	Conduit Clamp, 3/4" Silver



SMR Tilt -Up System

SMR Tilt-up is a single-row tilt-up system ideal for light roof structure application. Utilizing our new SMR rail and pop-on technology, the system offers various tilt degree options to maximize the power output at lower cost. Designed to meet the needs of a variety of roof structures, the installation is easy and quick to save your labor cost and time.



Flat and low-slope roof mounting L Foot, combined with tilt-up rails , provides versatile pitch angles. With a variety of attachment options, the system can be configured in endless ways to meet your specific needs.



SunModo offers three standard tilt-up rail lengths of 8, 14, and 25 inches to achieve tilt angles of 10 and 20 degrees. A 10-foot full-length tilt-up rail is also available for on-site cutting, allowing maximum flexibility. The top mount and side mount standoffs are available in 3 lengths.

Tilt-Up Rail



Part Number	Description
K10527-008-ML	Tilt Leg, 8", Mill Finish
K10527-014-ML	Tilt Leg, 14", Mill Finish
K10527-025-ML	Tilt Leg, 25", Mill Finish
A50265-120-ML	Tilt Leg Extrusion, 120", Mill Finish

Top Mount Standoff



Part Number	Description
A20055-004	4" Top Mount Standoff
A20055-006	6" Top Mount Standoff
A20055-008	8" Top Mount Standoff

Side Mount Standoff



Part Number	Description
A20056-005	5" Side Mount Standoff
A20056-007	7" Side Mount Standoff
A20056-009	9" Side Mount Standoff



SunTurf® Ground Mount System

SunModo offers the next generation of the Ground Mount System. The streamlined design combines the simplicity of a pipe-based system with next-level engineering. SunTurf Ground Mount is ideal for solar installers looking for a low-cost high performance system that can accommodate a wide variety of soil conditions.

SunTurf Ground Mount System easily integrates SMR300 Rails with Schedule 40 Steel Pipes. The innovative swivel pipe cap kit can accommodate terrains up to 27% slope east-west and 120% slope north-south. Combine SunTurf with our Ground Screws or Augers and do a complete install of a 15kW system with only one day on the job site.

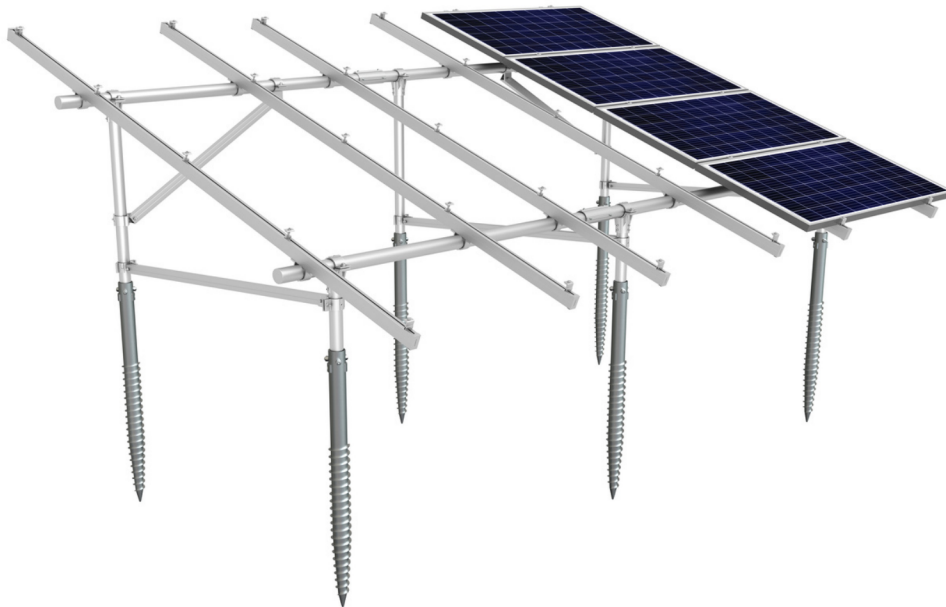

Position the Pipe Cap on top of the vertical pipe and lay the horizontal pipe into the Pipe Cap assembly.

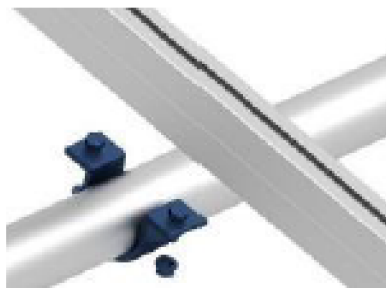

Attach the rail to the pipe using the aluminum pipe clamp kit. To prevent galvanic reaction, the PVC insulator must be installed between the steel pipe and the aluminum rail.

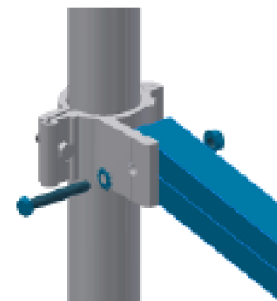

When bracing is required to a post, the pipe clamp kit is used.



SMR300

SMR300 rail is specially designed for the SunTurf system to maximize spans and optimize cost and performance. The rails can handle a variety of components, such as rail splices, micro-inverters, and clamps.

Manufactured in 2 stock sizes in mill finish. The rails are extruded 6005-T5 aluminum.

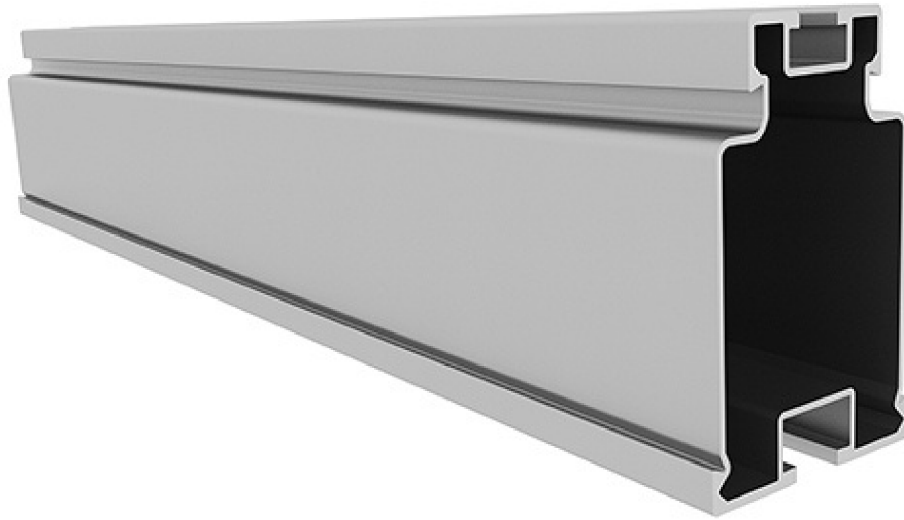

Part Number	Description
A20444-174-ML	SMR300 Rail, 174", Mill Finish
A20444-212-ML	SMR300 Rail, 212", Mill Finish
A20445-001	Rail End Cap, SMR300, Aluminum, Silver



SMR Pop-On Mid Clamp

The Bonding Pop-On Universal Mid Clamps accommodate PV module frame heights ranging from 30mm to 48mm. The fastest installing Mid Clamps on the market.

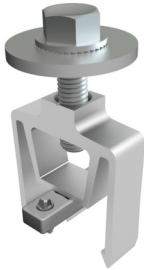

Part Number	Description
K10417-004	Mid Clamp, SMR Pop-On, Silver

SMR Pop-On End Clamp

End Clamps are adjustable for different module frame heights and provide fast and secure attachment of modules.

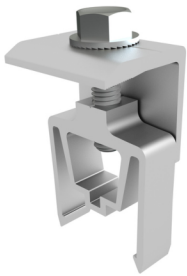

Part Number	Description
K10418-004	End Clamp, SMR Pop-On, Silver

SMR Structural Splice

Structural splice with fast and easy single bolt installation.



Part Number	Description
K10485-002	Rail Splice, SMR300

Grounding Lug

The Grounding Lug provides proper grounding of the PV System per UL 2703 and NEC 690.47

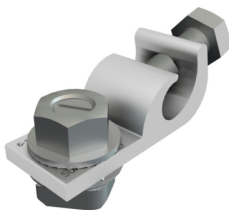

Part Number	Description
K10469-001	Grounding Lug, SMR



Swivel Pipe Cap Kit

This swivel pipe cap saves time and money by eliminating the need to grade the land before installing the PV array on sloped terrain.

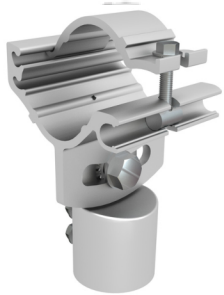

Part Number	Description
K10373-004	Swivel Pipe Cap, 2.5"

Pipe T-Clamp Kit

Position the T-Clamp Kit on top of the vertical pipe and lay the horizontal pipe into the Pipe Cap assembly.



Part Number	Description
K10341-002	Pipe Cap, 2.5"

Pipe Clamp Kit

The powder coated cast aluminum 2 piece clamps allows for quick installation of the braces, available in 2.0" and 2.5".



Part Number	Description
K10219-001	Pipe Clamp, 2"
K10222-001	Pipe Clamp, 2.5"



Pipe U-Clamp Kit

Attach the rail to the pipe using the U-Clamp Kit. To prevent galvanic reaction between dissimilar metals, the included PVC Insulator must be installed between the steel pipe and the aluminum rail.



Part Number	Description
K10343-005	Pipe U-Clamp, 2.5", SMR300

Pipe Splice Kit

Pipe Splice Kit provides bonding and strength between horizontal pipes when needed.



Part Number	Description
K10342-002	Pipe Splice, 2.5"

Steel Post Base Plate Kit

The steel post base can be used where a more robust connection is needed to resist higher wind and seismic loads.



Part Number	Description
K10268-005	Base Plate, Steel, 2" Pipe



Helical Screw Anchor

Helical screw anchors are suitable for use in weak to moderate strength soils and areas with a high water table.

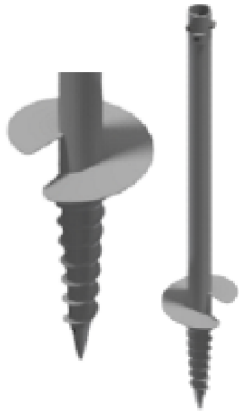

Part Number	Description
K10414-079	Helical Pile, 79", with set screws

Ground Screw Anchor

Ground screw anchors are suitable for use in hard packed earth or soils with large amounts of cobble and gravel. Set screws are included.

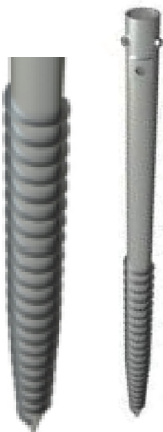

Part Number	Description
K10423-063	Ground Screw, 63", with set screws
K10423-080	Ground Screw, 80", with set screws



Diagonal Brace

The high strength steel diagonal tube brace provides extra support as needed.



Part Number	Description
A50164-092	Brace, HSS Tube, 92"
A50164-120	Brace, HSS Tube, 120"

12-Gauge High Strength Steel (HSS) Pipe

SunModo provides either a 2" (2.375" O.D.) or 2.5" (2.875" O.D.) 12-gauge, HSS, hot dip galvanized pipe with a minimum 50 KSI yield strength. 2.5" HSS pipe end caps provide a clean finished look to the system.



Part Number	Description
A21165-060	Pipe, HSS, 2", 60"
A21165-120	Pipe, HSS, 2", 120"
A21168-112	Pipe, HSS, 2.5", 112"





Racking Partner of Professional Installers

SunModo Corp.
Vancouver, WA., USA
www.sunmodo.com
360.884.0048
info@sunmodo.com



Solar installation professionals rely on a single partner for all their mounting and racking needs. SunModo is dedicated to providing innovative racking solutions that help you install systems quickly and painlessly. Our products already set the standard for durability, safety, and security, and our R&D Team is constantly engineering affordable, hassle-reducing innovations that meet industry standards. You can access our products through our preferred distributors.

ABOUT SUNMODO

SunModo is a private U.S. company focused on innovative racking and mounting solutions for professional installers in the fast-growing solar industry. We are energized every day by a desire to make solar installation easier, more reliable, and more affordable. Our commitment to innovation can be seen across our entire product line, which includes 20-plus industry-shaping patents.

